

End of topic quiz - Topic 1.3 Computer networks, connections and protocols

1. What are **two** advantages of networking computers? [2 marks]

2. What does **WAN** stand for? [1 mark]

3. What is the definition of 'bandwidth'? [1 mark]

4. What does the acronym **Mbps** stand for? [1 mark]

5. Write about the impact that bandwidth can have on the performance of a network. [3 marks]

In your answer you might consider:

- the speed of the network.
- the type of media being accessed.
- the number of users.

6. What are the differences and similarities between a **LAN** and a **WAN**? [2 marks]

7. A large supermarket chain is setting up a new client server network. What is meant by the term 'client server network'? [2 marks]

8. You plan to use a peer network model for a business. What are **two** reasons why you have chosen this network model? [2 marks]

9. A home internet connection goes through a hybrid device. What **three** network devices does it typically contain? [3 marks]

10. What is the purpose of a router? [1 mark]

11. What does **DNS** stand for? [1 mark]

12. You want to check out the latest team news for your favourite football club www.soccerfc.com. When you type the address into a browser, the page loads. The main steps that take place during this process are detailed below. Place these steps in order in the flow chart: [11 marks]

1. Enter URL into browser
2. DNS responds with details of the name server
3. Name server responds with IP address of the host
4. Server hosting the site sends across content
5. ISP sends IP address to the browser
6. Browser requests IP address of site from ISP
7. Website displayed to the user
8. ISP asks name server for site IP address
9. Browser receives website content
10. Browser sends request to the server hosting the site
11. ISP requests IP address from DNS server

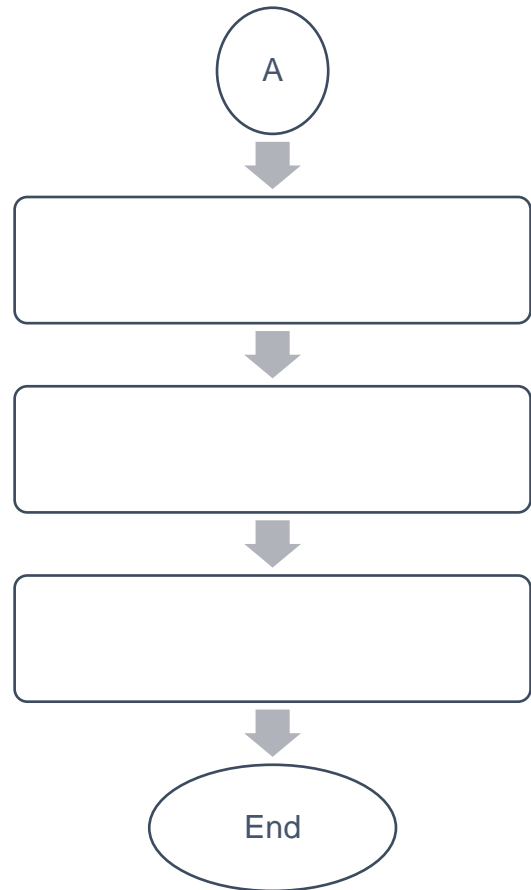
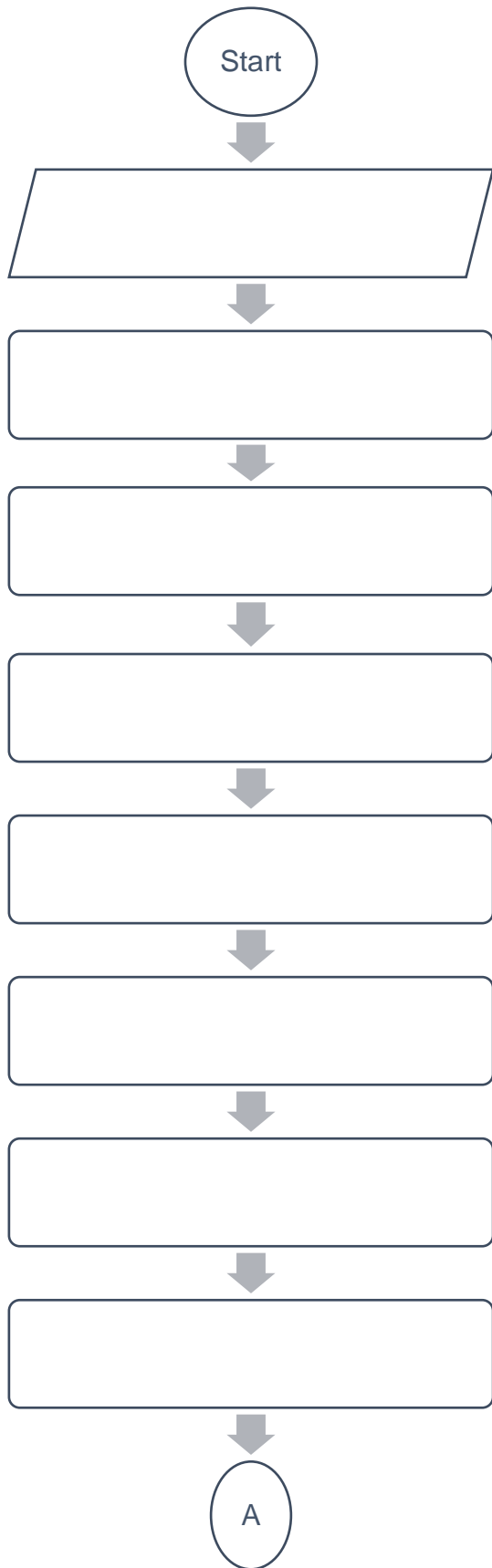

13. Many fast broadband connections use fibre optic cable instead of copper. What are **two** reasons why fibre optic cable is the preferred choice? [2 marks]

14. Why is using cloud computing useful to some businesses? [2 marks]

15. What is the role of a web server? [1 mark]

16. What is the role of a web client? [1 mark]

17. You have a games console in your bedroom and a video streaming device in your lounge. You use both devices to watch movies. The Wireless Access Point is located in the lounge. You have found that you are able to stream movies at a far higher quality in the lounge than in your bedroom. Why is this? [2 marks]

18. Fill in the table with whether each of the statements are true or false [5 marks].

| Statement | True/False |
|---|------------|
| A peer-to-peer network has one central controlling computer. | |
| Peer-to-peer networks are easier to set up than client-server networks. | |
| Peer-to-peer networks allow individual devices to share files between each other. | |
| Peer-to-peer networks are commonly used in large organisations. | |
| It is easier to implement security procedures throughout a client server network than a peer to peer network. | |

19. Using the following components, design how a client server network may be set up [5 marks].

- Server
- 2 x workstations
- Switch
- Printer



20. When clicking a hyperlink to a webpage, which device is the server, which device is the client and what communication happens between them? [3 marks]

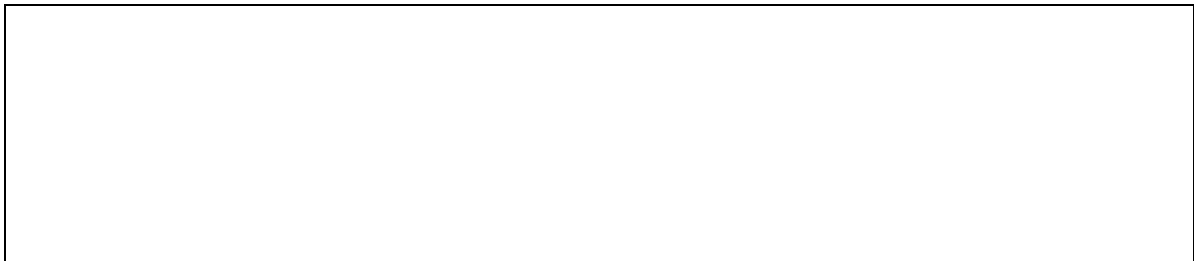

21. Draw the links between four workstations using a full mesh network topology [2 marks].

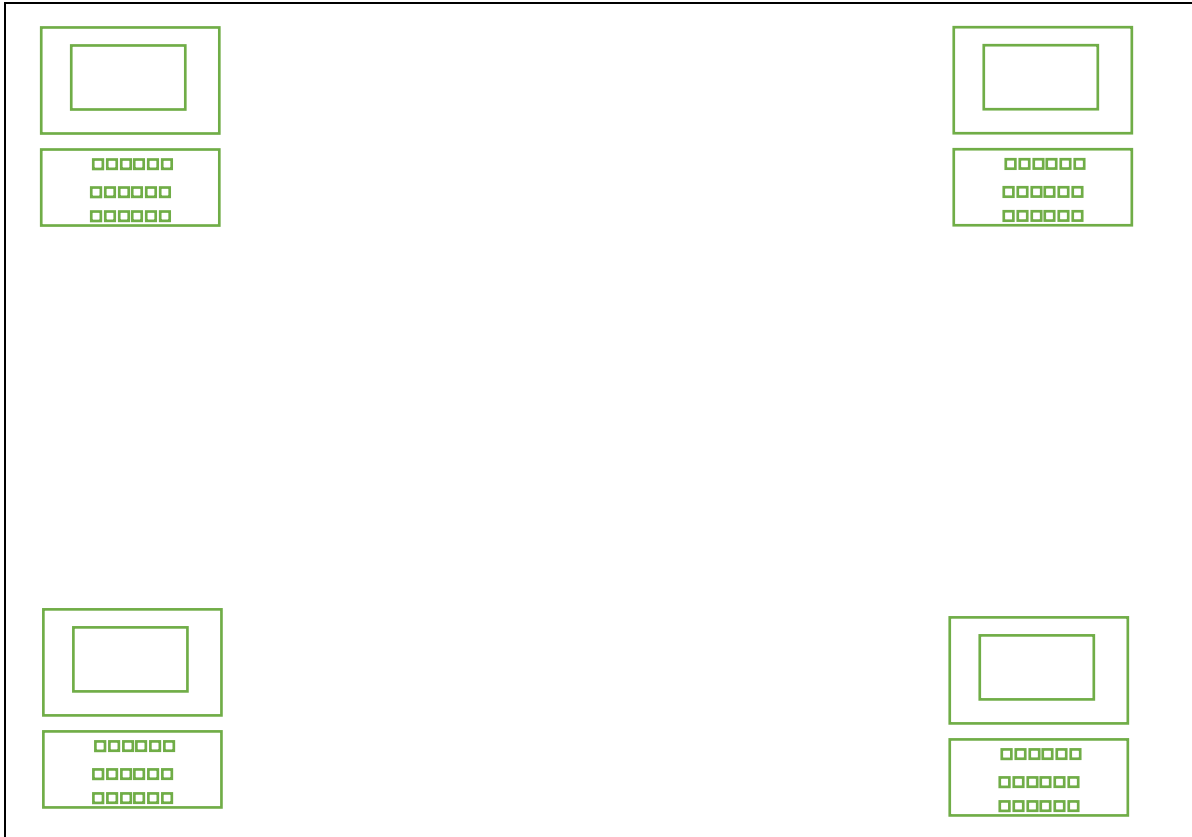

22. You are setting up a new network using a Star network topology.

a. Draw the Star network topology using two workstations, a server and a switch. [2 marks]



b. What are **two** reasons a Star network topology has been used to set up the new network?
[2 marks]

23. What are **two** disadvantages of using a Star network topology instead of a Mesh network topology? [2 marks]

24. What is the definition of 'protocol'? [1 mark]

25. What does the term **POP** stand for? [1 mark]

26. What is the protocol that is used to transmit data between different networks? [1 mark]

27. What is the difference between **HTTP** and **HTTPS**? [1 mark]

28. Match the protocol to its characteristic [3 marks]

| |
|------|
| HTTP |
| IMAP |
| SMTP |

| |
|---|
| Used to retrieve emails |
| Used by web browsers to communicate with web servers. |
| Used to send emails. |

29. Protocols are divided into layers. Why are layers used? [1 mark]

30. What is the difference between an IP address and a MAC address? [2 marks]

31. What is the difference between IPv4 and IPv6 addresses? [1 mark]

32. What is the following 6 byte in hexadecimal? [2 marks]

10100110:11000001:10010000:00010010:10011110:00110110

33. What does the acronym **FTP** stand for? [1 mark]

34.

a. What does the acronym **POP3** stand for? [1 mark]

b. What is the purpose of **POP3**? [1 mark]

35. Fill in the table below with either true or false. [5 marks]

| Statement | True / False |
|---|--------------|
| A peer-to-peer network has one central controlling computer. | |
| Peer-to-peer networks are easier to set up than client-server networks. | |
| Peer-to-peer networks allow individual devices to share files between each other. | |
| Peer-to-peer networks are commonly used in large organisations. | |
| It is easier to implement security procedures throughout a client server network than a peer to peer network. | |

36. What are three differences between Bluetooth and Wi-Fi? [2 marks]

Answers

1. What are **two** advantages of networking computers? [2 marks]

- It is easy to share documents. Different users can work on the same document at once.
- Only one internet connection is required as it can be shared between every device connected to the network.
- Centralised backups can be carried out automatically.
- Software updates/patches can be automatically pushed out by the server to ensure that all devices are up to date.
- Users can log in to any machine connected to the LAN as accounts are stored centrally on the server.

2. What does **WAN** stand for? [1 mark]

Wide Area Network.

3. What is the definition of 'bandwidth'? [1 mark]

Bandwidth is the amount of data that can be transmitted in a given period of time.

4. What does the acronym **Mbps** stand for? [1 mark]

Megabits Per Second.

5. Write about the impact that bandwidth can have on the performance of a network [3 marks].

In your answer you might consider:

- the speed of the network.
- the type of media being accessed.
- the number of users.

Indicative content:

The amount of available bandwidth has a major impact on the performance of a network. The larger the amount of available bandwidth that is available the more data that can be transmitted in a given period of time.

If there is a large number of users on the network the amount of bandwidth available to each user may be limited. This will result in data being transmitted at a slower rate which will slow down the performance of the network.

Where large media files are being streamed the amount of available bandwidth is particularly important. Should a number of users be watching streaming HD content demand on bandwidth will be high. If there is insufficient bandwidth this could result in a reduction of quality in the video.

6. What are the differences and similarities between a **LAN** and a **WAN**? [2 marks]

A LAN covers a small geographical area whereas a WAN covers a wide geographical area.
All of the telecommunications equipment used in a LAN is owned by the organisation whereas a telecommunications company provides infrastructure for a WAN.

7. A large supermarket chain is setting up a new client server network. What is meant by the term 'client server network'? [2 marks]

All devices are connected to a central server.
The central server receives and processes requests from 'clients'.
The server stores user account details and files.

8. You plan to use a peer network model for a business. What are **two** reasons why you have chosen this network model? [2 marks]

- All devices have equal status, there is no central server which makes them relatively easy to maintain.
- There is no dependence on the server. If one device fails only the information stored on that device will be inaccessible. The network will still operate without that node.
- They are relatively easy to set up without the need for a network manager.

9. A home internet connection goes through a hybrid device. What **three** network devices does it typically contain? [3 marks]

Router
Switch
Wireless access point

10. What is the purpose of a router? [1 mark]

To transmit data between at least two different networks.

11. What does **DNS** stand for? [1 mark]

Domain Name System.

12. You want to check out the latest team news for your favourite football club www.soccerfc.com. When you type the address into a browser, the page loads. The main steps that take place during this process are detailed below. Place these steps in order in the flow chart:

- 12.** Enter URL into browser
- 13.** DNS responds with details of the name server
- 14.** Name server responds with IP address of the host
- 15.** Server hosting the site sends across content
- 16.** ISP sends IP address to the browser
- 17.** Browser requests IP address of site from ISP
- 18.** Website displayed to the user
- 19.** ISP asks name server for site IP address
- 20.** Browser receives website content
- 21.** Browser sends request to the server hosting the site
- 22.** ISP requests IP address from DNS server

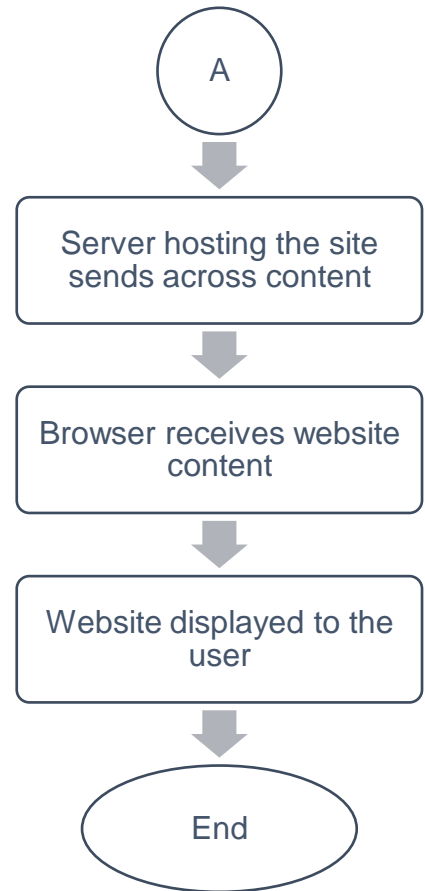
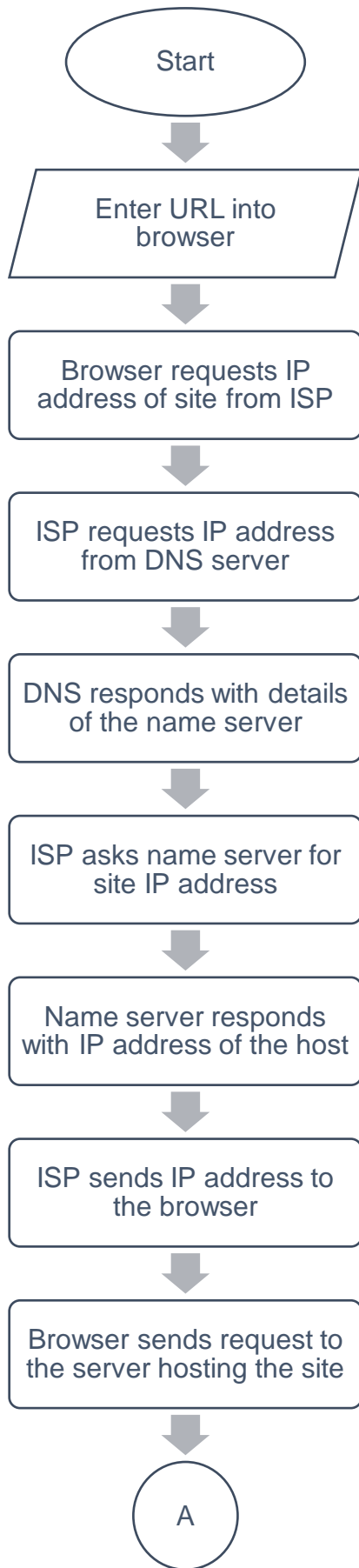

[11 marks]

13. Many fast broadband connections use fibre optic cable instead of copper. What are **two** reasons why fibre optic cable is the preferred choice? [2 marks]

- Fibre optic cables transmit data through light so do not suffer from electrical interference.
- Data can be transmitted over very large distances without any loss of signal quality.
- They are able to transmit data at a higher bandwidth.

14. Why is using cloud computing useful to some businesses? [2 marks]

- Any user within the business will be able to load up the files on any device in any location as long as they have a data connection and the necessary permission.
- If they runs out of storage capacity it is easy to increase.
- All of the hardware and maintenance tasks will be performed by the cloud provider, they will not have a pay for specialist staff.
- The data will be automatically backed up.
- There is no large upfront cost. They will just have to pay a regular fee for the cloud services.

15. What is the role of a web server? [1 mark]

- Control access to a centralised resource (definition of a server)
- Stores content for web pages
- Stores layout data for web pages
- Receives and processes requests for web pages

16. What is the role of a web client? [1 mark]

- Sends requests for web pages
- Sends DNS requests for IP addresses
- Displays the results of web requests

17. You have a games console in your bedroom and a video streaming device in your lounge. You use both devices to watch movies. The Wireless Access Point is located in the lounge. You have found that you are able to stream movies at a far higher quality in the lounge than in your bedroom. Why is this? [2 marks]

- The further the device is from the WAP the weaker the signal will be, so the lower the bandwidth will be.
- Objects such as walls and doors will reduce the signal strength.
- Other electrical devices could reduce the signal strength and interfere with the signal.

18. Fill in the table with whether each of the statements are true or false [5 marks].

| Statement | True / False |
|---|--------------|
| A peer-to-peer network has one central controlling computer. | False |
| Peer-to-peer networks are easier to set up than client-server networks. | True |
| Peer-to-peer networks allow individual devices to share files between each other. | True |
| Peer-to-peer networks are commonly used in large organisations. | False |
| It is easier to implement security procedures throughout a client server network than a peer to peer network. | True |

19. Using the following components, draw how a client server network may be set up [5 marks].

- Server
- 2 x workstations
- Switch
- Printer

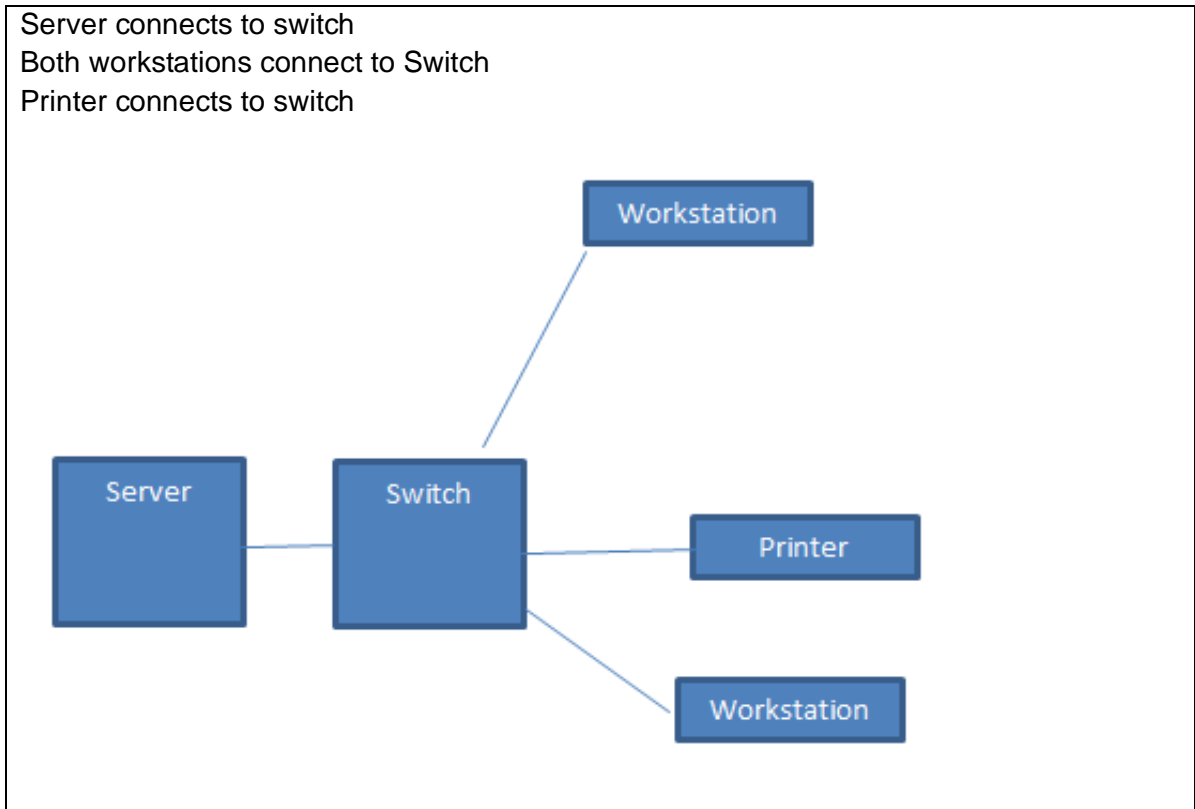

20. When clicking a hyperlink to a webpage, which device is the server, which device is the client and what communication happens between them? [3 marks]

The webserver is the device that stores the webpage data.
 The client is the computer that requested the web page.
 When clicking a hyperlink, the client sends a request to the webserver.
 The webserver processes the request and prepares the webpage.
 The webpage is then sent to the client.
 The webpage is opened in the client's browser.

21. Draw the links between four workstations using a full mesh network topology [2 marks].

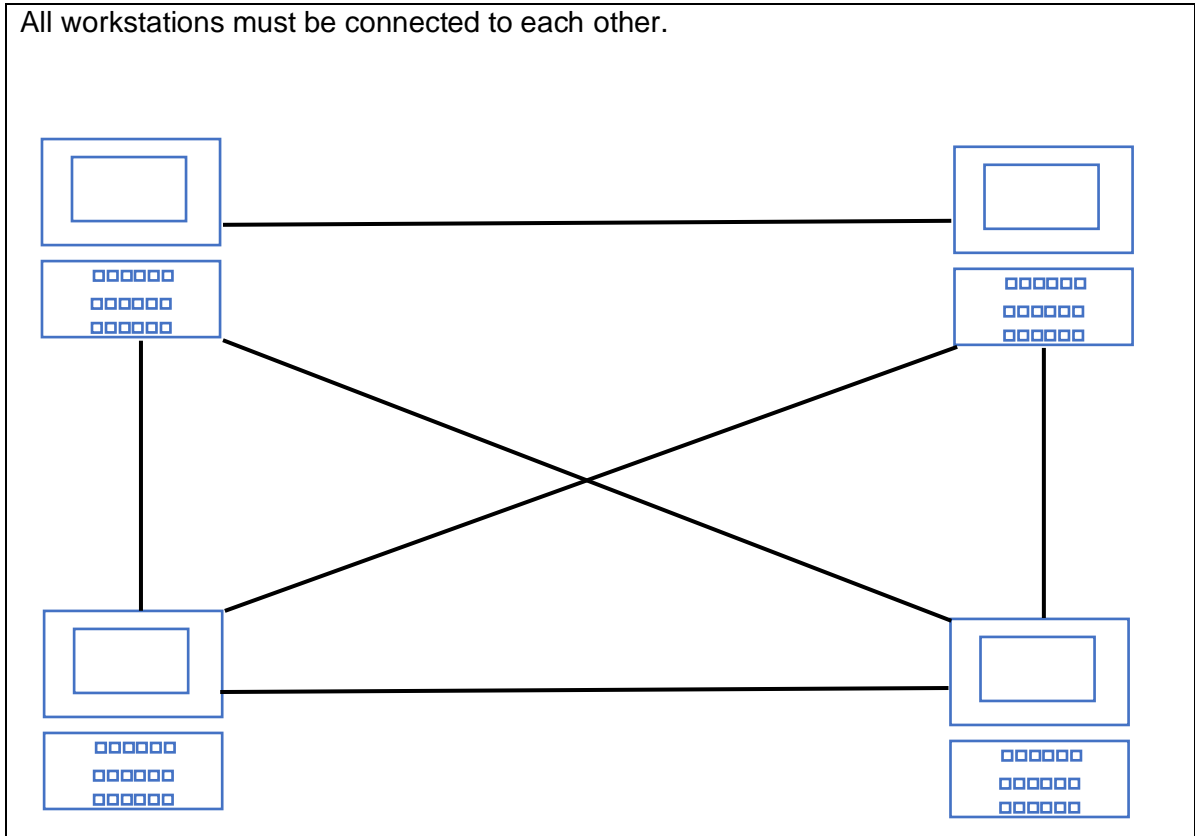

22. You are setting up a new network using a Star network topology.

a. Draw the Star network topology using two workstations, a server and a switch [2 marks].

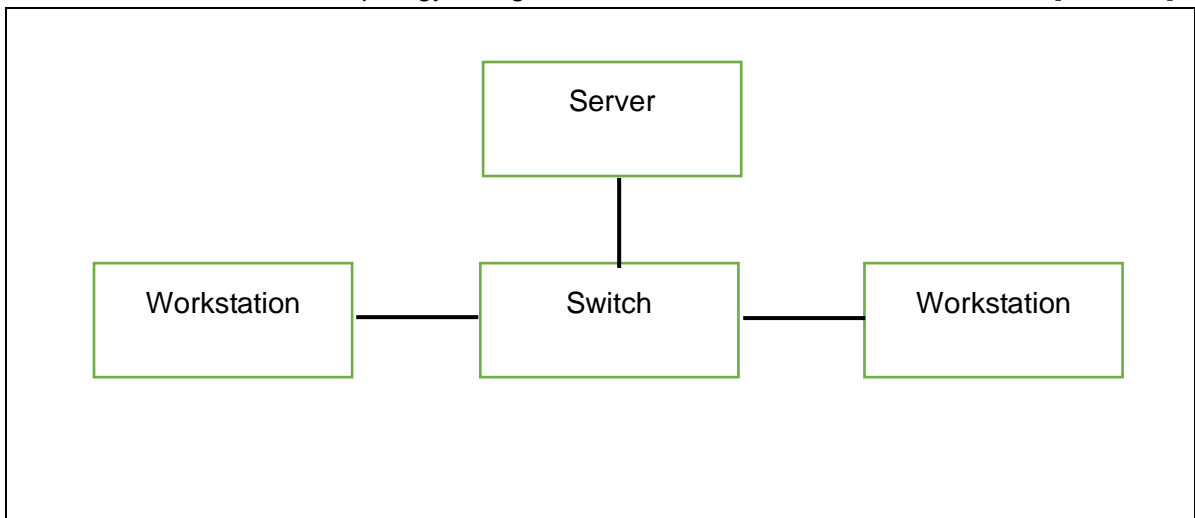

b. What are **two** reasons a Star network topology has been used to set up the new network? [2 marks]

- They are very reliable.
- If one connection fails it does not affect the rest of the network.
- It is relatively easy to add additional devices onto the network.
- It is relatively fast as each device has its own connection to the switch / server.
- There are few data collisions.

23. What are **two** disadvantages of using a Star network topology instead of a Mesh network topology? [2 marks]

- There is a high level of dependence on one single, central device.
- If the central device fails the whole network will fail.
- The use of a switch or router could increase the cost of the whole network.
- The performance of the network will be dependent upon the specification of the central device/switch.
- The number of additional devices that can be added to the network could be restricted by the central device/switch.

24. What is the definition of 'protocol'? [1 mark]

A set of rules that govern how devices communicate.

25. What does the term **POP** stand for? [1 mark]

Post office protocol.

26. What is the protocol that is used to transmit data between different networks? [1 mark]

Transmission Control Protocol / Internet Protocol. TCP/IP.

27. What is the difference between **HTTP** and **HTTPS**? [1 mark]

HTTP transmits data over the internet in an unsecure format whereas HTTPS uses encryption so that any data that is intercepted is meaningless.

28. Match the protocol to its characteristic [3 marks].

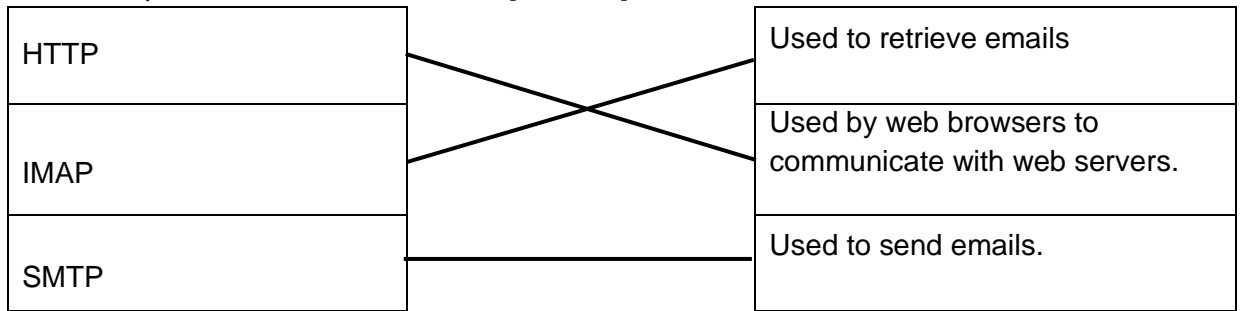

29. Protocols are divided into layers. Why are layers used? [1 mark]

- Network communication components are standardised which helps to ensure that different types of hardware and software are able to communicate.
- Through separating the overall network communication processes it makes troubleshooting easier should an error occur.
- To ensure that if changes are made in one layer they do not affect any other layers
- Through dividing overall network communication into smaller, individual components it makes the software development process more straightforward.

30. What is the difference between an IP address and a MAC address? [2 marks]

A MAC address is permanently assigned to a device on the network whereas an IP address may change when the device joins a different network.

31. What is the difference between IPv4 and IPv6 addresses? [1 mark]

IPv4 – 4 blocks of denary digits between 0 and 255 Values separated by full stops.
IPv6 – 8 blocks of 4 hexadecimal digits Values separated by colons.

32. What is the following 6 byte in hexadecimal? [2 marks]

10100110:11000001:10010000:00010010:10011110:00110110

A6:C1:90:12:9E:36

33. What does the acronym **FTP** stand for? [1 mark]

File Transfer Protocol.

34.

a. What does the acronym **POP3** stand for? [1 mark]

Post Office Protocol version 3.

b. What is the purpose of **POP3**? [1 mark]

To retrieve emails, only award the mark for retrieve (or similar). The protocol cannot be used to send emails.

35. Fill in the table below with either true or false [5 marks].

| Statement | True / False |
|---|--------------|
| A peer-to-peer network has one central controlling computer. | False |
| Peer-to-peer networks are easier to set up than client-server networks. | True |
| Peer-to-peer networks allow individual devices to share files between each other. | True |
| Peer-to-peer networks are commonly used in large organisations. | False |
| It is easier to implement security procedures throughout a client server network than a peer to peer network. | True |

36. What are three differences between Bluetooth and Wi-Fi? [2 marks]

Bluetooth uses less power
 Bluetooth has a shorter range
 Bluetooth has a slower data transfer speed
 Bluetooth is normally used for ad-hoc connections
 Bluetooth is normally used for personal devices/as part of a PAN, rather than a LAN

OCR Resources: the small print

OCR's resources are provided to support the delivery of OCR qualifications, but in no way constitute an endorsed teaching method that is required by the Board, and the decision to use them lies with the individual teacher. Whilst every effort is made to ensure the accuracy of the content, OCR cannot be held responsible for any errors or omissions within these resources.

Our documents are updated over time. Whilst every effort is made to check all documents, there may be contradictions between published support and the specification, therefore please use the information on the latest specification at all times. Where changes are made to specifications these will be indicated within the document, there will be a new version number indicated, and a summary of the changes. If you do notice a discrepancy between the specification and a resource please contact us at: resources.feedback@ocr.org.uk.

© OCR 2020 - This resource may be freely copied and distributed, as long as the OCR logo and this message remain intact and OCR is acknowledged as the originator of this work. OCR acknowledges the use of the following content: n/a
 Please get in touch if you want to discuss the accessibility of resources we offer to support delivery of our qualifications: resources.feedback@ocr.org.uk